

BASIC TOOLS AND EQUIPMENT

Fig. 1

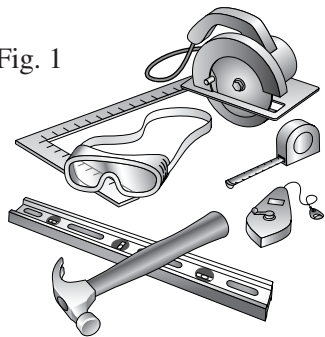

Hand Tools

Common hand tools, such as a hammer, saw, square, chalkline, level, and tape measure are needed for proper installation (Fig. 1). Safety glasses are recommended for eye protection. Other basic tools include:

Power Saw

A bench or radial-arm power saw can speed the cutting of the siding. A finetooth blade (12 to 16 teeth per inch) should be used with the blade installed in the reverse direction. Some applicators prefer a hand-held power saw and a field-built cutting table. In extremely cold weather, move the saw through the material slowly to prevent chipping or cracking (Fig. 2).

Fig. 2

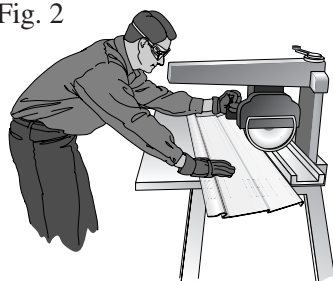

NOTE: A saw blade set up in reverse direction should be used only for cutting vinyl. **DO NOT** attempt to use it on other materials such as wood, plywood, etc.

Fig. 3

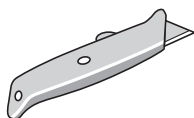

Utility Knife

Vinyl is easy to cut, trim and score with a utility knife or scoring tool (Fig. 3).

Tin Snips

Good quality tin snips and compound aviation-type snips will speed the cutting and shaping of the vinyl (Fig. 4).

Snaplock Punch

A snaplock punch is used to punch lugs in the cut edges of siding to be used for the top or finishing course at the top of a wall, or underneath a window (Fig. 5).

Nail Hole Punch

Occasionally, it may be necessary to elongate a nail slot. The hole is elongated to allow for expansion and contraction (Fig. 6).

Unlocking Tool (Zip-Lock Tool)

Remove or replace a siding panel with the unlocking tool. Insert the curved end of the tool under the end of the panel and hook onto the back lip of the buttlock. To disengage the lock, pull down and slide the tool along the length of the panel. Use the same procedure to relock a panel (Fig. 7).

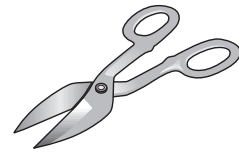

Fig. 4

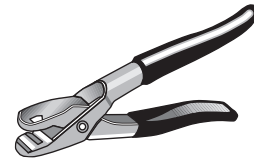

Fig. 5

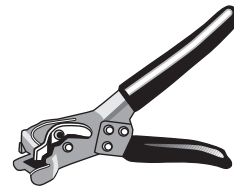

Fig. 6

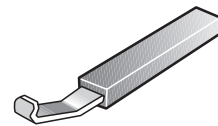

Fig. 7